



# Hunter

stoves



## HERALD 8, 14, 80b & High Output Inglenook

Multi-fuel Room Heaters and  
High Output Boiler Models

Need a multi-fuel stove that can run your heating and water?  
 Discover our new high-output collection.

If you're looking for a complete home heating solution, you'll find it in these pages. The Herald 8, 14, high output Inglenook and 80b have all been designed with our acclaimed technology and style – add an optional boiler, and all your heating needs are met.

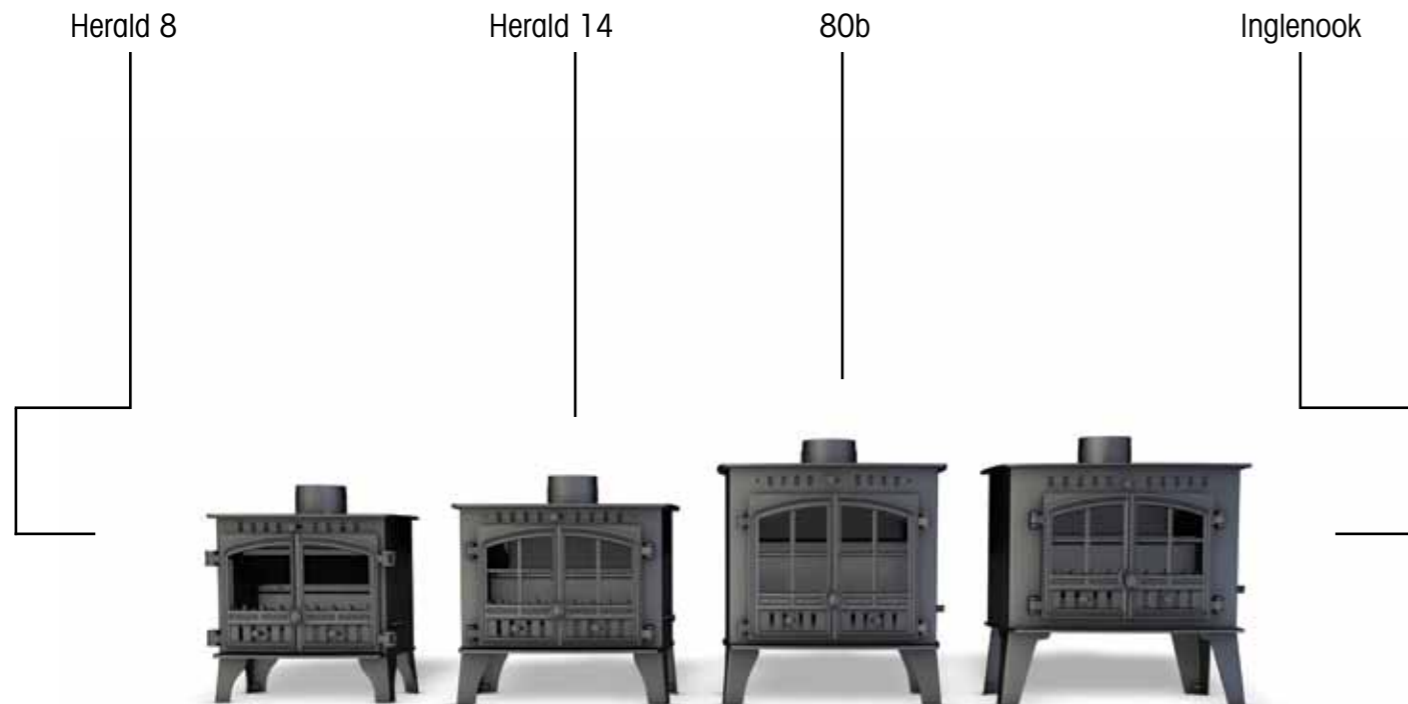

NB. All images are for illustrative purposes only

## Contents

Inspired by the past,  
 ready for the future...

Herald 8	page 2-5
Herald 14	page 6-9
Double Sided	page 10-13
High Output Inglenook	page 14
Central Heating	page 16-21
Herald 8 and 14 features	page 22
Cleanburn technology	page 24
Options	page 26
FAQs	page 27
Technical specifications	page 28-37

Herald Double Sided



# Herald 8

Multi-Fuel Stove



The Herald 8, like all our stoves, carries CE certification.



## Solid good looks

The solid good looks of the Herald 8 along with its mid-sizing, contribute to this being one of the best selling Hunter stoves in the multi-fuel range. The cleanburn technology and full CE approval guarantee the Herald 8 stove meets the high environmental expectations from today's discerning consumer.

Numerous styling options ensure the Herald 8 sits comfortably in the most traditional of settings or even those of a more contemporary nature.



Herald 8 Flat Top with traditional crossed doors

## Technical Key

- Herald 8 CE Tested and approved at 7.5 - 9kW output with max of 11kW 
- Cleanburn technology 
- Exceptionally hot airwash 
- Multi-fuel grate for burning wood and solid fuel 
- Dust free, safe and easy riddling 
- Easy access for chimney sweeping 
- All double door options have removable crosses as standard 
- Wraparound and clip-in boiler options 

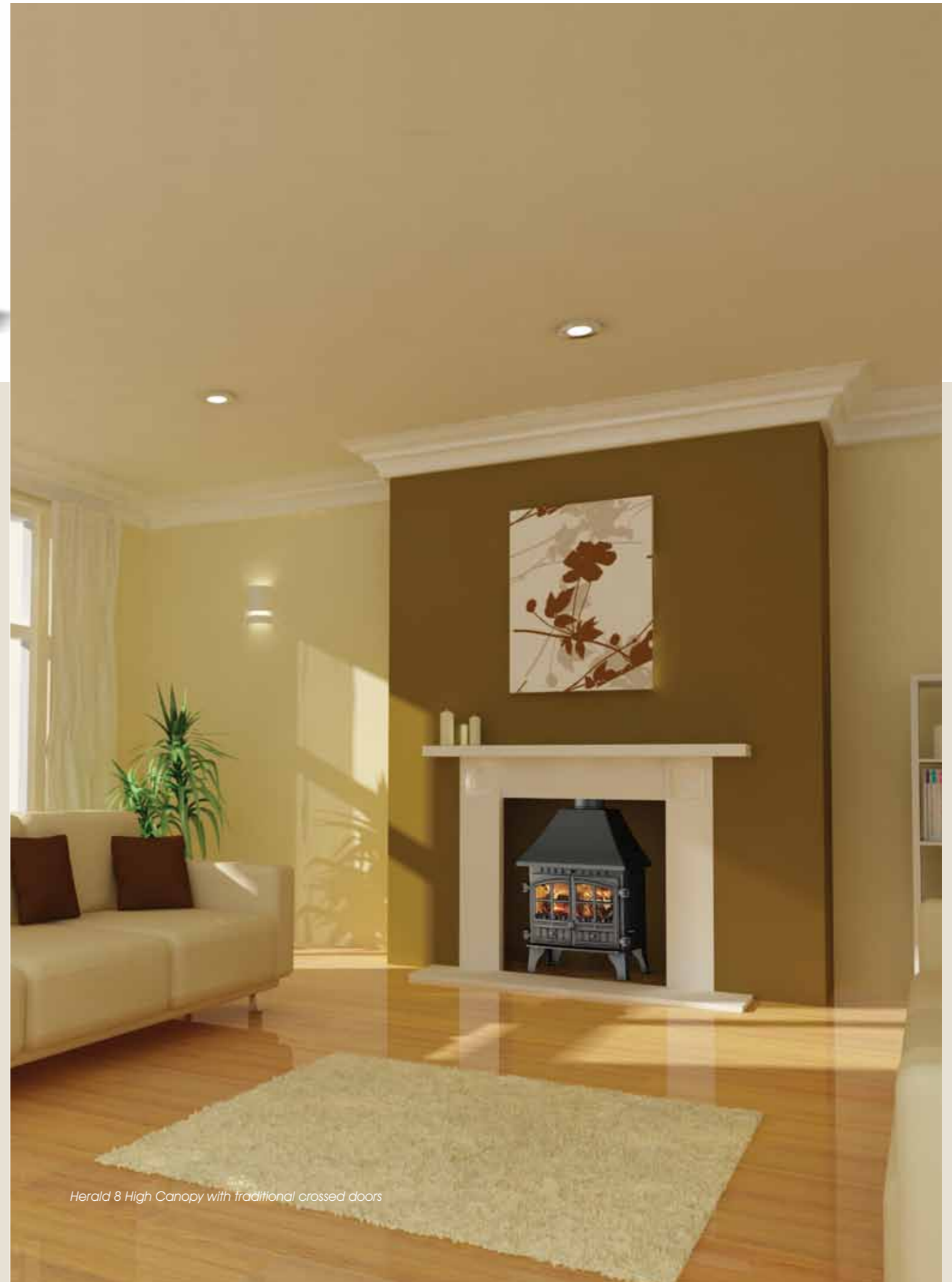

Herald 8 High Canopy with traditional crossed doors

# Herald 8

Multi-Fuel Stove



A range of options allows you to customise your Herald 8. Pictured with high canopy.



## Customise your stove

Every Herald 8 is built with the same painstaking craftsmanship and acclaimed engineering. But only one is yours. Make it perfect by choosing the fuel, style and extras. For a country look, you could add a canopy hood (High or Low), and old-fashioned crossbars on the windows. If you're eco-conscious, you can set up your Herald 8 to burn wood (the original 'carbon neutral' fuel). And the Herald 8 can, of course, be adapted to heat your home and water – turn to page 14 for advice on choosing a clip-in or wraparound boiler.



Herald 8 Low Canopy with traditional crossed doors



Herald 8 flat top with single door option

# Herald 14

Multi-Fuel Stove



Characteristically capable – the Herald 14 works hard and looks great. Pictured with high canopy and single door option.



## Highly efficient

The Herald 14 is the third largest of the Herald multi-fuel stoves and capable of providing a very significant heat output. Its large size makes it particularly suitable for a big fireplace or where there is a requirement to heat a larger than average sized room.

Integral cleanburn technology and full CE approval are also features of the Herald 14 stove, ensuring a highly efficient stove and a clean environment.

### Technical Key

CE Tested and approved at 11.5kW output with max of 15kW	
Cleanburn technology	
Exceptionally hot airwash	
Multi-fuel grate for burning wood and solid fuel	✓
Dust free, safe and easy riddling	✓
Easy access for chimney sweeping	✓
All double door options have removable crosses as standard	✓
Wraparound and clip-in boiler options	✓
CE tested for overnight burning for over 12 hours on solid fuel	✓



Herald 14 Low Canopy with traditional crossed doors



Herald 14 Low Canopy with traditional crossed doors

# Herald 14

Multi-Fuel Stove



Choose from the options to customise your stove - pictured with window bars.



## Capable provider

Wake up and warm your toes by the Herald 14 – this hardworking stove can be left to glow for 12 hours, so it's always ready to welcome you home. With a max heat output of 15KW, it's capable of heating your home all day and night – add a wraparound boiler (page 16), and it can power up to 10 radiators. And did we mention the energy savings? Our Cleanburn system means that heat is continually redirected into the room. That's not just good for your family, but for the environment too – use wood logs for the lowest emissions.



Herald 14 High Canopy with plain doors



Herald 14 Flat Top with single door

# Herald 8-14 Double Sided

Multi-Fuel Stove



Two of our models can be double-sided, including the Herald 8 Flat Top double depth with single door option







## Transform your space

Warm up your open-plan living space with a dramatic fire. Open on both sides, it radiates heat throughout the space, transforming your environment with flickering firelight.

The Herald 8 and 14 are both available as double-sided models, with the 14 offering a maximum heat output of 17kW.

### Technical Key

CE Tested and approved at the following outputs	 
Herald 8 double sided single depth 7.6 - 8.9 kW	✓
Herald 8 double sided double depth 11 kW	✓
Herald 14 double sided single depth 11.6 - 12.5 kW	✓
Herald 14 double sided double depth 17.8kW	✓
Suitable for island installations	✓
Cleanburn technology	
Exceptionally hot airwash	
Multi-fuel grate for burning wood and solid fuel	✓
Dust free, safe and easy riddling	✓
Easy access for chimney sweeping	✓
All double door options have removable crosses as standard	✓



Herald 8 Flat Top double sided single depth with traditional crossed doors



Herald 14 double sided single depth with single doors

# Herald 8 - 14 Double Sided

Multi-Fuel Stove



Customise your stove by choosing depth, doors and canopy (pictured).



## Bespoke build

Choose from the Herald 8 or Herald 14. Then make it yours by specifying the depth, doors, and features.

First, do you require a single or double-sized stove? Double depth gives you a larger fuel bed and even better heat output. You can also specify what door combination you would like (see illustrations), and whether you would like a canopy (high or low). The choice is yours.



*Herald 8 Flat Top, double sided, double depth with double doors*



*Herald 8 flat top double sided, double depth stove with single door option*

*See page 25 for example of Double Door option*

# Inglenook High Output Stove

Multi-Fuel Stove



The high output Inglenook, with contemporary single door



## Traditional values

This endearingly traditional stove incorporates the very best of modern technology – like our Cleanburn system, and a hot Airwash to keep the glass clean. Throw on another log and enjoy the old-fashioned ambience while the Inglenook heats your home. This astonishingly high capacity stove is perfect for large homes... or romantic evenings for two.

### Technical Key

Nominal heat output of 9.2kw max 20kw

Cleanburn technology



Exceptionally hot airwash



Up to 73% Efficient

Multi-fuel grate for burning wood and solid fuel



Dust free, safe and easy riddling



Easy access for chimney sweeping



All double door options have removable crosses as standard



Inglenook High Output Stove with high canopy and traditional crossed doors

# Herald 8 Central Heating Stoves

Multi-Fuel Stove



A high canopy gives the stove a more traditional appearance.



Herald 8 Flat Top with plain doors



## Fit for purpose

Add a wraparound or clip-on boiler to the Herald 8, and it becomes a complete home heating solution. Use the diagrams to identify the boiler that's best for you.

### Wraparound Boiler

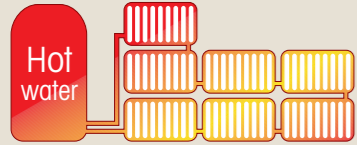

Output to water Output to room

Nominal\* output when burning wood

6.0kW 2.0kW

Nominal\* output when burning smokeless fuel

6.3kW 1.7kW

Maximum output

8.5kW (29,000 BTU) 2.5kW

### Clip-in Boiler



Output to water Output to room

Nominal\* output when burning wood or smokeless fuel

5.0kW 1.5kW

Maximum output

5.5kW (18,750 BTU) 2.5kW

\*Nominal = the minimum achievable heat output

### Technical Key

CE Tested and approved at 6kW output with max of 8.5kW (boiler output)



Exceptionally hot airwash



Up to 73% efficient



Multi-fuel grate for burning wood and solid fuel



Dust free, safe and easy riddling



All double door options have removable crosses as standard



Optional thermostat



# Herald 14 Central Heating Stoves

Multi-Fuel Stove



Make your stove work harder - the Herald 14 can be fitted with a boiler.



## Work harder

Equipped with an optional boiler, the Herald 14 can run up to 10 radiators – as well as your hot water. Choose a wraparound or clip-in boiler, depending how much power you need.

### Wraparound Boiler

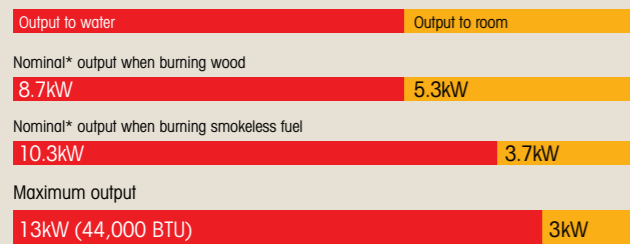
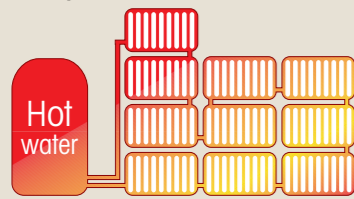



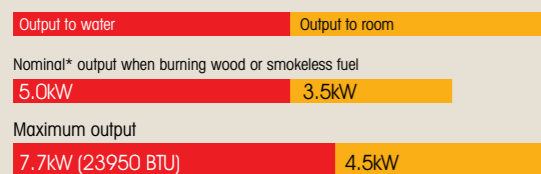



### Clip-in Boiler



\*Nominal = the minimum achievable heat output

### Technical Key

- CE Tested and approved at 8.7kW output with max of 13kW (boiler output) 
- Exceptionally hot airwash 
- Up to 73.6% efficient
- Multi-fuel grate for burning wood and solid fuel 
- Dust free, safe and easy riddling 
- All double door options have removable crosses as standard 
- Optional thermostat 



Herald 14 High Canopy with single door option

# Herald 80b Central Heating Stove

Multi-Fuel Stove









The Herald 80b can run up to 15 radiators.



## Instant wow factor

New to the Hunter range of stoves is the impressive Herald 80B, a large multi-fuel stove with an exceptional heating capacity, suitable for larger properties powering up to 15 radiators. This really is a beast of a stove!

### Technical Key

- CE Tested and approved at 12.4kW output with max of 16kW (boiler output) 
- Exceptionally hot airwash 
- Up to 71% efficient
- Multi-fuel grate for burning wood and solid fuel 
- Dust free, safe and easy riddling 
- All double door options have removable crosses as standard 
- Optional thermostat 

### Wraparound Boiler

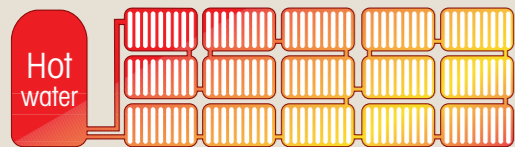

Output to water	Output to room
Nominal* output when burning wood 12.4kW	9.1kW
Nominal* output when burning smokeless fuel 12.5kW	4.5kW
Maximum output 16kW (54,600 BTU)	10kW

\*Nominal = the minimum achievable heat output



Herald 80B with Flat Top and traditional crossed doors

# Herald 8 and 14 Range

Features



The Herald stove collection



## CE Tested and Approved

All the stoves in the Herald 8 and 14 Range meet the stringent CE approval test requirements.

## New Hunter Cleanburn Technology

Cleanburn technology means that more of the fuel is ignited, resulting in an increased heat output, less smoke, and a cleaner environment.

## Exceptionally Efficient

Currents of air inside the stove ensure that fuel is burnt evenly and efficiently.

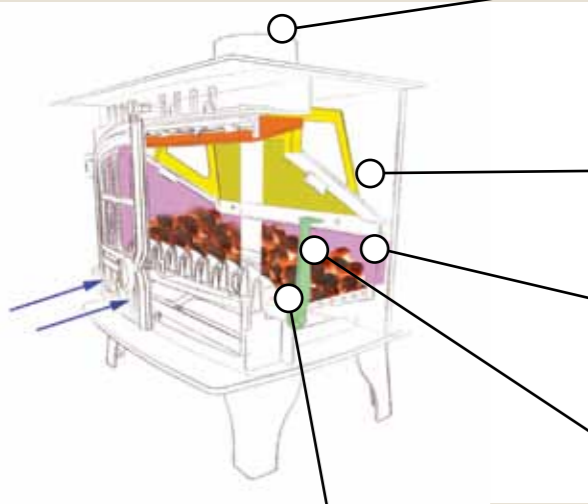

## Safe and Efficient for Over-Night Burning

By reducing the air inflow to an absolute minimum, you can keep the fire gently smouldering overnight. Come morning, increase the air flow and the fire will return to life.

## Dust Free, Safe and Easy Riddling

The riddling tool enables you to clean the grate without causing clouds of dust. Just move it back and forth with the doors closed.

## Interchangeable Flue Outlets

All of the stoves in the Herald 8, 14 and 80b Range can be flued from either the top or the rear of the stove.

## Easy Access for Chimney Sweeping

Every stove features a removable throat-plate, giving full and easy access for sweeping the chimney.

## Internal Lining System

The new internal lining system maximises the firebox temperature, ensuring complete combustion.

## Cold-handled Riddling Tool

The cold-handled riddling tool can be used for opening and closing the doors, riddling the grate, grate adjustment and easy removal of the ash-pan.

## From Wood to Multi-Fuel with a Single Movement of the Tool

The stove's integral grate can be changed from wood to multi-fuel setting with a single movement of the cold-handled riddling tool.

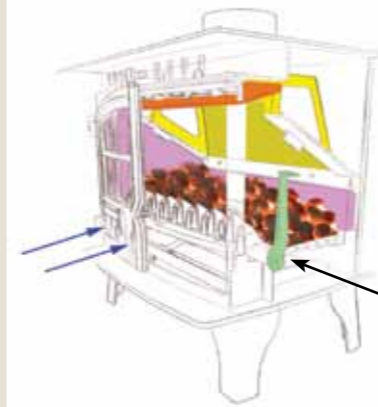
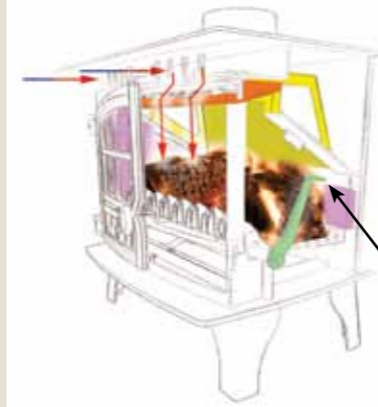
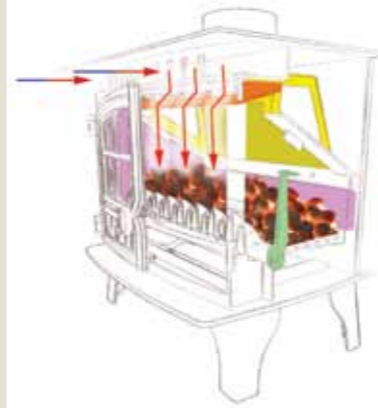

## No need to scrub the glass door

Our innovative airwash draws air from the top of the stove, heats it up in the central air chamber and then sends it down behind the glass door, creating a screen between the fire and the glass. Smoke or combustion particles do not come into contact with the glass, so you don't need to clean it.

## Optimum Woodburning Conditions

Three streams of hot air ensure that fuel is burned efficiently by maximising combustion. For wood, close the grate and allow a deep bed of ash to build up - the optimum conditions for combustion.

## Optimum Solid Fuel Burning Conditions

When you're burning smokeless fuel, just switch the grate to the open position. Air flows beneath the grate and into the heart of the fire - the optimum conditions for burning solid fuel.

Grate in 'back' closed position for burning wood

Grate in 'forward' open position for burning solid fuel

# Cleanburn technology

Multi-Fuel Stoves



CLEANBURN is our innovative new technology – it's not just better for the stoves, it's also better for the environment.

The idea behind Cleanburn is to maximise combustion, so that more fuel is burnt and less is turned into deposits in the stove, chimney, or atmosphere. Our Cleanburn stoves have been proven to have lower emissions, which makes them among the most eco-friendly models on the market.

**The Hunter Herald stoves are approved twice; for burning both wood and smokeless fuel**



'Tertiary Air' re-ignites the un-burnt gases ensuring a cleaner burn.

The New Hunter 'Internal Lining System' maximises the firebox temperature, ensuring complete combustion.



Herald 14 High Canopy double sided, double depth stove with plain doors

# Options

FOREST GREEN (subtle green with metallic tint), and CLOUDY BLUE (grey-blue with metallic tint).



Whichever Hunter stove you choose, you have a number of options to make it perfect for your interior. Talk to your supplier about the choices available on each stove. Here's an overview of the possibilities:

## FINISHES

Every stove is built in 5mm steel, but you can choose the finish you'd like. Top image, L-R: FOREST GREEN (subtle green with metallic tint), and CLOUDY BLUE (grey-blue with metallic tint).

## SINGLE OR DOUBLE DOOR?

The larger models are available with a single door or double door. While the single door option provides a better viewing window, the double door gives a traditional appearance. Double doors also come with removable window crosses.

## SINGLE OR DOUBLE-SIDED?

The Herald 8 and 14 can be built as double-sided stoves, which means both sides have doors. You can opt to have these in a double depth, too, so the fuel bed is larger.



Optional multi-fuel front extension for larger fuel loads

## CANOPY?

Most models have a matching canopy which you can choose to add to your purchase.

Optional flue gather box, for rear flue installations and limited space installations



- Flat top, low canopy or high canopy models (Herald 8,14 & High Output Inglenook Stove)
- Flat top, clip-on low canopy (Herald 80b )
- Single or double depth, double sided models (Herald 8 & 14 )
- Wraparound boiler option
- Woodburning only option
- Single door option ( Herald 8,14 & High Output Inglenook Stove )
- Flue damper
- Spark guard
- Variable leg length
- MIDNIGHT finish with optional FOREST GREEN or CLOUDY BLUE
- A single brass door knob or set of brass door knobs
- Thermostat for central heating units

# FAQs

## DOES HUNTER SELL DIRECT TO THE PUBLIC?

No; we have a network of trusted dealers with showrooms throughout the UK and Ireland. To locate your nearest dealer, drop us a quick email at [sales@hunterstoves.co.uk](mailto:sales@hunterstoves.co.uk), or telephone 0044 (0) 1392 841744.

## HOW DO I GET MY NEW STOVE INSTALLED?

Installation must be carried out by a Hetas-approved or similarly qualified engineer and must be in accordance with Building Regulations. To investigate the suitability of your chimney, contact your local dealer, who will be pleased to arrange a site visit. This is very important, because the condition of your chimney will determine how well your stove performs; a poor chimney system will affect its efficiency. Any existing flue must be swept and inspected before installation of the stove. All multi-fuel/wood burners must be installed in a class 1 chimney.

## WHAT IF I DON'T HAVE A CHIMNEY?

There are many different flue systems available. Please contact your local dealer/ flue installer, who will be able to give you personal advice.

## CAN I CONNECT TWO STOVES TO ONE FLUE SYSTEM?

No. All Hunter Stoves must be individually flued.

## MY STOVE HAS A 6" FLUE COLLAR; CAN I INSTALL IT ON A 5" FLUE?

No. The internal diameter of the flue must be no smaller than the appliance flue collar for its entire length.

## DOES MY CHIMNEY NEED LINING?

This is to be decided by your qualified Engineer.

## DO I NEED AN AIR BRICK?

Yes if the output is above 5kw. (See page 28)

## WHAT TYPE OF FUEL CAN I USE?

The quality of fuel will dictate the performance of your Hunter Stove.

## WOODBURNING

Burn only dry, well seasoned wood. For best results, use dry wood, with a moisture content of less than 20%, which has been cut, split and stacked for at least 12 months. This is advertised as 'seasoned' wood. Burning wet or unseasoned wood will create tar deposits in the stove and chimney and won't produce a satisfactory heat output. Wood burns best on a bed of ash and it is therefore only necessary to remove surplus ash from the stove occasionally.

## PEAT

Only to be used in turf or brick form, but the moisture content must be very low.

## SOLID FUEL BURNING

Anthracite is an approved natural smokeless fuel (not processed) but can vary greatly in quality and performance. It generally requires excellent air supply to maintain maximum performance and with experience we would suggest that it is used in conjunction with other approved manufactured smokeless fuels as per the HETAS approved list.

Please visit [www.hetas.co.uk](http://www.hetas.co.uk) for an up to date list of approved Manufactured Smokeless Fuels suitable for closed appliances.

*Only authorised smokeless fuels may be used in smoke control areas.*

**Warning!** - Petroleum coke fuels or household waste must not be burnt on our appliances. Should any difficulties arise over fuel quality or suitability, consult your approved coal merchant or the Solid Fuel Advisory Service – Telephone 0845 6014406.

## CAN I BURN WOOD ON MY MULTI-FUEL GRATE?

Yes. All Hunter multi-fuel appliances are capable of burning wood.

## CAN I SWEEP MY CHIMNEY THROUGH THE STOVE?

Yes – it is possible to sweep the chimney through the stove, if a damper is not fitted

A clip-in boiler installation should have an additional means of access to the flue system to allow cleaning – usually a soot door in the first length of flue pipe.

## CAN I RUN MY BOILER STOVE DISCONNECTED?

No. The stove should not be fired with the boiler disconnected or empty, as this could cause serious damage to the appliance.

## HOW MUCH SPACE WILL MY STOVE NEED?

All our units require a clearance of 150mm (6") on either side, and 50mm (2") clear at the back. The hearth should extend 300mm (12") in front of the appliance (From the door opening). All of these clearance specifications are for non combustible materials.

## SPARK GUARDS

Our multi-fuel stoves have been tested and CE certified by an approved independent testing facility, to the current CE legislation. In addition to this all of our stoves exceed the minimum efficiency requirements as set out by the English & Welsh Building Regulations part L. In order to achieve this, all of our stoves are tested as closed appliances and therefore must be documented accordingly. Some customers choose to run appliances with the doors open. In doing this they accept that the operating characteristics of the stove might change. This is a personal choice and it is the reason that we supply Spark Guards, as an option. If our stoves are run with the doors open then the operation of the flue, ventilation to the room and the quality of the fuel will need to be very good, in order to prevent smoke spillage into the room. Not all installations will be able to achieve this.

# Technical Key

Multi-Fuel Stoves



	Herald 8	Herald 14	Herald 8	Herald 8	Herald 14	Herald 14		Herald 8	Herald 14	Hunter 80b	Inglenook
	Room Heater	Room Heater	Double single	Double Double	Double single	Double Double		Central Heating (29000btu boiler)	Central Heating (44000btu boiler)	Central Heating (54,600btu boiler)	Room Heater
output nominal	7.5-9 kw	9-11.5 kw	7.6-8.9 kw	11 kw	11.6-12.5	17.8		1.7-2.5kw	3.7-5.3	4.5-10	9.2 - 20kw
Efficiency on wood %	78.9	78.6	74.3	79	75.7	71.1		73.4	73.6	71	73
Flat Top	✓	✓	✓	✓	✓	✓		✓	✓	✓	✓
Low Canopy option	•	•	•	•	•	•		•	•	•	•
High Canopy Option	•	•	•	•	•	•		•	•	~	•
Double door option	✓	✓	✓	✓	✓	✓		✓	✓	✓	✓
Single door option	•	•	•	•	•	•		•	•	~	•
Multi Fuel Option (Riddling Grate)	•	•	•	•	•	•		•	•	•	•
Wood Burning only option	•	•	•	•	•	•		•	•	•	•
Black knob set	✓	✓	✓	✓	✓	✓		✓	✓	✓	✓
Brass Knob	•	•	•	•	•	•		•	•	•	•
Full Brass Set	•	•	•	•	•	•		•	•	•	•
Flue Damper	•	•	•	•	•	•		•	•	•	•
Sparkguard <sup>3</sup>	•	•	•	•	•	•		•	•	~	•
Multi fuel Extention	•	•	•	•	•	•		•	•	~	•
Coloured finish	•	•	•	•	•	•		•	•	•	•
Non Standard Leg Height <sup>1</sup>	•	•	•	•	•	•		•	•	•	•
Clip in Boiler Option <sup>2</sup>	•	•	~	~	~	~		~	~	~	~
Flue Gather Box	•	•	~	~	~	~		•	•	~	•
Ventilation (mm <sup>2</sup> )	2255	4950	2145	3520	4565	7040		2255	4950	9075	TBA
Leg lengths	6" - 152mm	6" - 152mm	6" - 152mm	6" - 152mm	7" - 178mm	7" - 178mm		6" - 152mm	7" - 178mm	8" - 200mm	9 1/4 - 235mm
Log length (approx)	19 3/4 - 500mm	19 3/4 - 500mm	19 3/4 - 500mm	19 3/4 - 500mm	19 3/4 - 500mm	19 3/4 - 500mm		19 3/4 - 500mm	19 3/4 - 500mm	21" - 533mm	19 3/4 - 500mm



Optional wood front



Optional brass door knob



Optional spark guard



Optional flue damper

✓ = standard  
• = option  
~ = not available

1. Optional Leg Height - you specify the size, we make to order

3. Sparkguard - only available on double door options

2. Boiler output, see page 16 - 18

# Herald 8, 14, 80b and High Output Inglenook

## Technical Specifications

All the Herald stoves are manufactured from high quality 5mm thick steel and have cast iron components. They feature the new Hunter Cleanburn Technology, they all burn wood, smokeless fuels and peat on a dust-free de-ashing system, and have a hot airwash system keeping the glass clean to see through.



### Herald 8

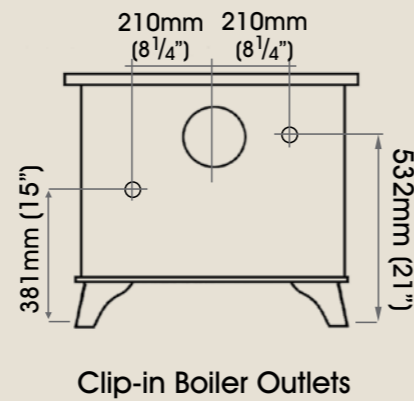
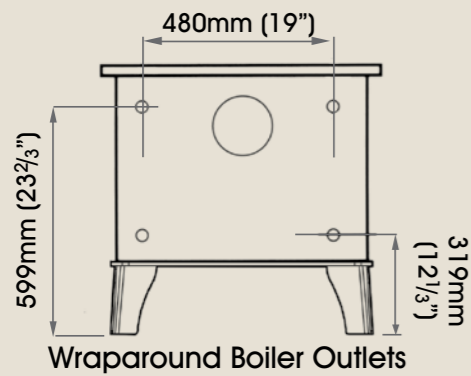
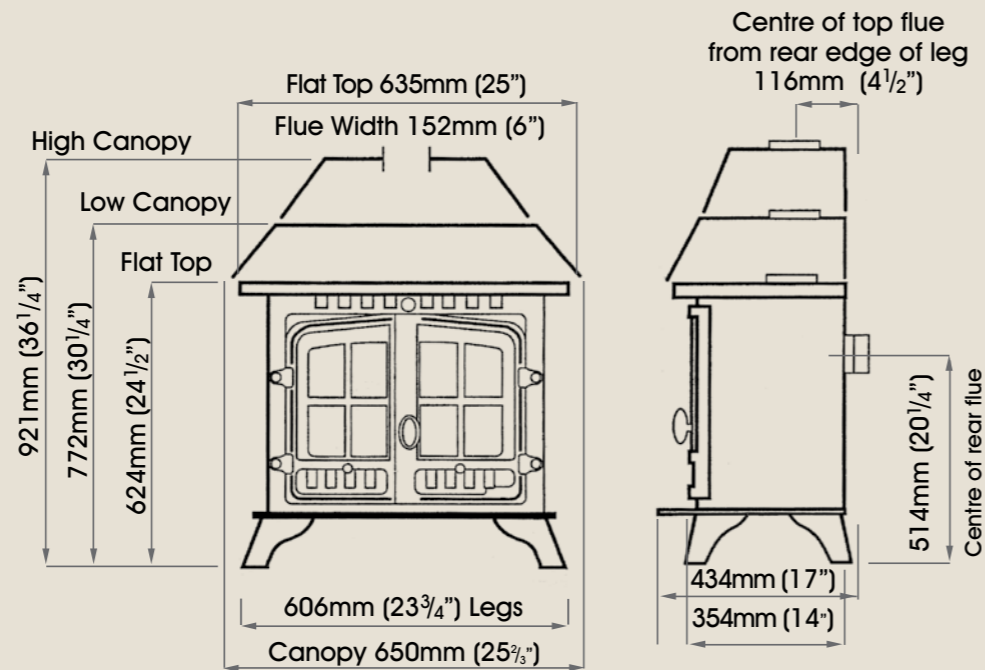

All dimensions shown are with standard 6" (152mm) leg lengths  
All boiler outlets are 1" BSP

Width of body measurement

6" leg lengths subtract 24 mm off leg to leg measurement to obtain body width.

Approximate weights

	Herald 8	With Wraparound Boiler	With Clip-in Boiler
Flat Top	120Kg	135Kg	130Kg
Low Canopy	125Kg	141Kg	135Kg
High Canopy	128Kg	149Kg	138Kg



Herald 8 Flat Top with single door option

# Herald 14

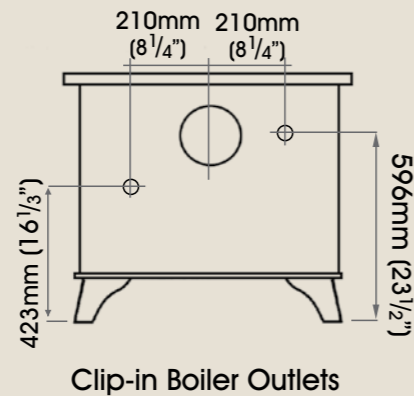
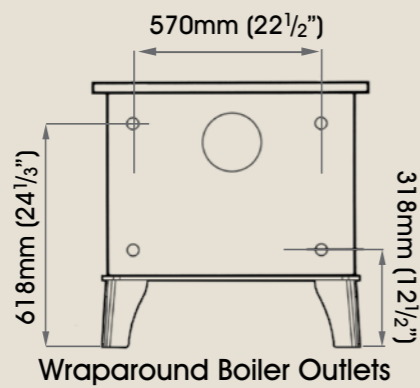
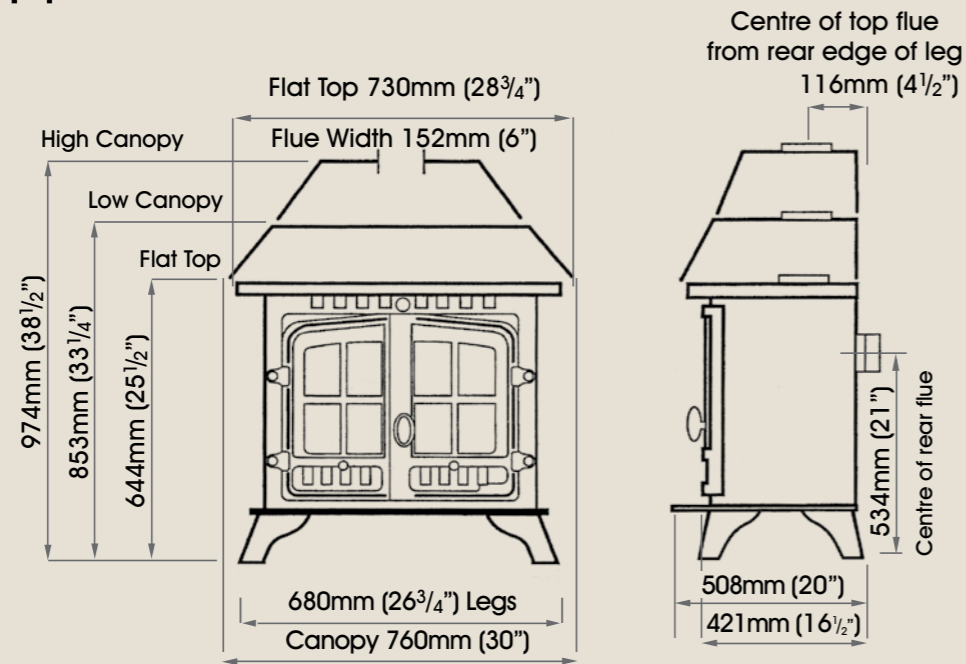

All dimensions shown are with standard 7" (178mm) leg lengths  
All boiler outlets are 1" BSP

Width of body measurement

7" leg lengths subtract 32 mm off leg to leg measurement to obtain body width.

	Approximate weights		
	<b>Herald 14</b>	<b>With Wraparound Boiler</b>	<b>With Clip-in Boiler</b>
Flat Top	145Kg	168Kg	155Kg
Low Canopy	148Kg	177Kg	158Kg
High Canopy	155Kg	182Kg	165Kg

# Herald 8 Double sided stoves

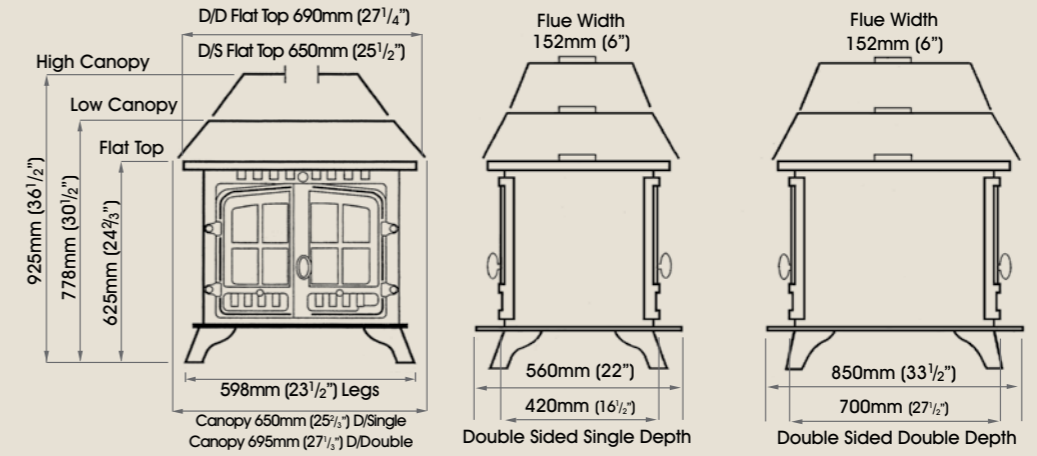

All dimensions shown are with standard 6" (152mm) leg lengths

Approximate weight

	<b>Double Sided Single Depth</b>	<b>Double Sided Double Depth</b>
Flat Top	140Kg	220Kg
Low Canopy	145Kg	230Kg
High Canopy	148Kg	236Kg

# Herald 14 Double sided stoves

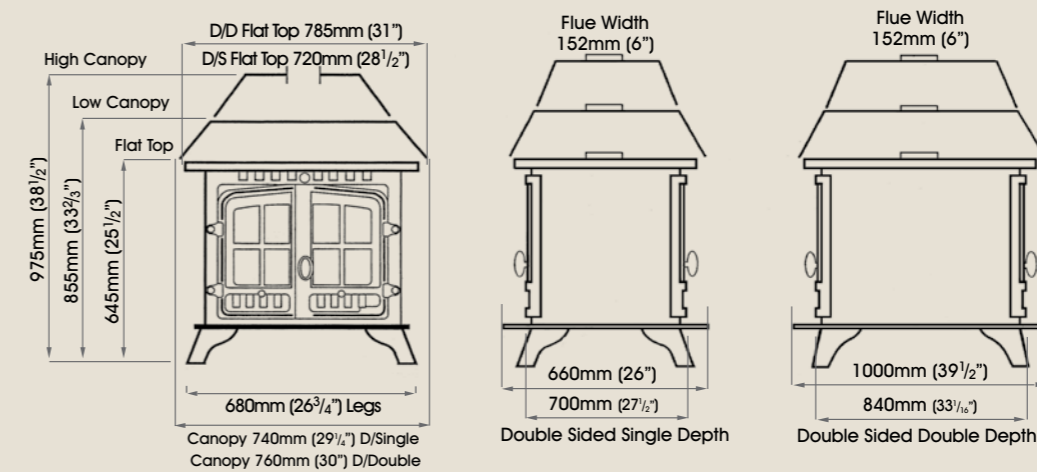

All dimensions shown are with standard 7" (178mm) leg lengths

Approximate weights

	<b>Double Sided Single Depth</b>	<b>Double Sided Double Depth</b>
Flat Top	165Kg	270Kg
Low Canopy	168Kg	276Kg
High Canopy	175Kg	290Kg

# Herald 80B

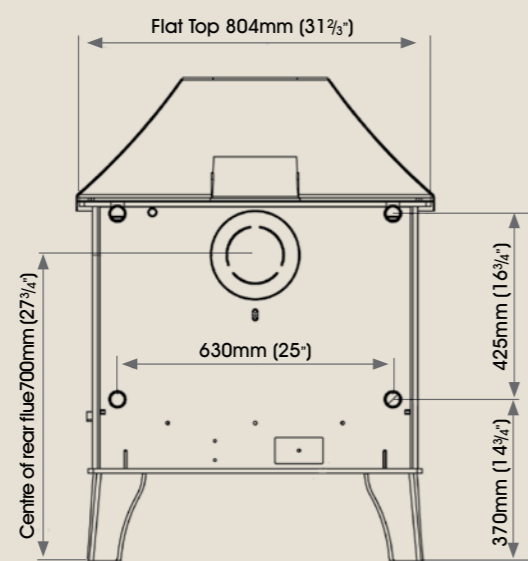
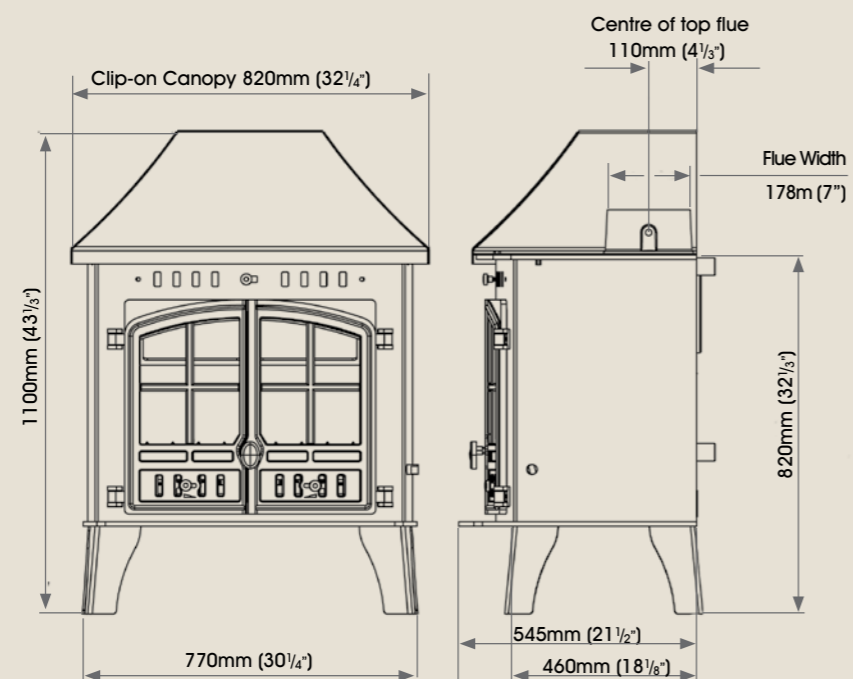

Boiler Outlets

All dimensions shown are with standard 8" (200mm) leg lengths  
All boiler outlets are 1" BSP

Width of body measurement

6" leg lengths subtract  
34 mm off leg to leg  
measurement to obtain body  
width.

Approximate weights  
Flat Top 218Kg  
Canopy Kit 23Kg



Herald 80B with Flat Top and traditional crossed doors

# Inglenook High Output Stove

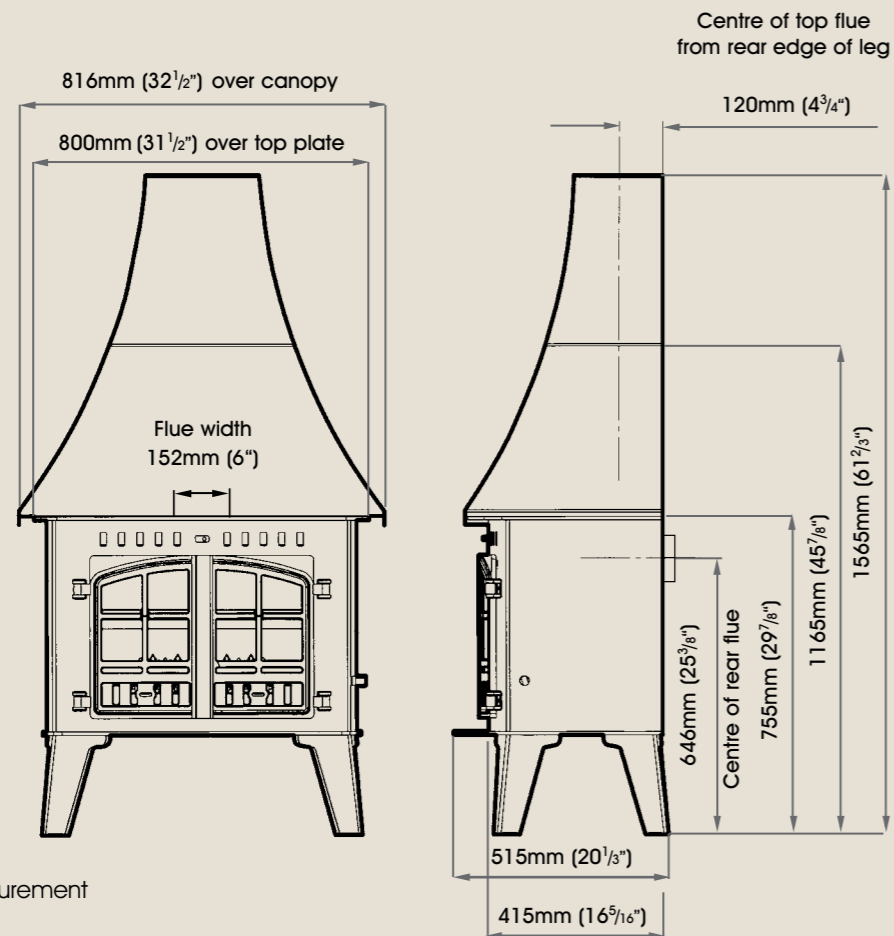

Width of body measurement

9 1/4" leg lengths subtract 235 mm off leg to leg measurement to obtain body width.



Room and boiler heat outputs are dependent on fuel load and installation parameters. Overnight burning is dependent on fire box size, fuel load etc. Many thanks to Essex Fireplaces, B D Brooks Fireplaces and Focus Fireplaces for the provision of fireplaces/photography. Hunter Stoves Limited has a policy of continuous product improvement and therefore reserves the right to change specifications and designs at any time without prior notice.

Hunter Stoves Ltd. strongly recommends that the suitability of any installation should firstly be agreed with a HETAS qualified installer or similarly competent professional, to ensure compliance with the recent changes to the Building Regulations. Hunter Stoves Ltd. will not be held responsible for any losses, however arising, from inappropriate installations by unqualified or non-competent installers. An inappropriate installation may also invalidate claims made under a manufacturer's warranty or guarantee.

NB. All are shown with standard 91/4 235mm leg lengths. All dimensions shown are approximate measurements and can change due to manufacturing tolerances. Outputs for the High Output Inglenook have been calculated in-house, awaiting independent results, therefor output may vary.

Your Local Stockist

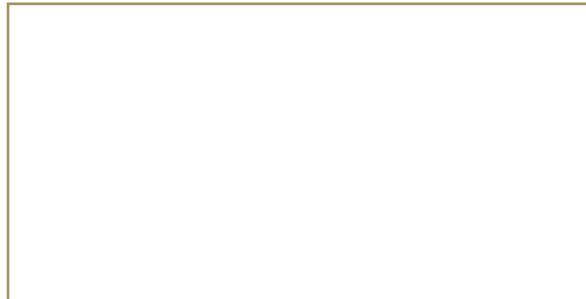

Hunter Stoves Limited  
Unit 6 Old Mill Industrial Estate  
Stoke Canon  
Devon EX5 4RJ